



# Modular Access Chamber System



Field Installation Guidelines

[www.humes.co.nz](http://www.humes.co.nz) 0800 502 112

# Contents

---

Introduction .....	2
Safety .....	2
Hazards .....	3
Staffing requirements .....	3
Equipment & additional materials.....	3
Site preparation .....	5
Chamber assembly .....	7
Chamber installation .....	8
Chamber bracing.....	10
Chamber backfill .....	10
Finishing the installation.....	11
Shuttering Installation.....	12
Shuttering Installation visual guide.....	13
Standards .....	14
Contacts .....	14

## **Modular Access Chamber System** Field Installation Guidelines

Version 4: November 2011

The purchaser is responsible for correctly applying these installation guidelines. Humes does not accept any responsibility for performance problems, direct, indirect or consequential losses arising from any failure to correctly install the equipment in accordance with these guidelines.



# Introduction

---



## Safety

---

Throughout the installation process, the site must be properly signed and guarded with suitable barriers to ensure the safety of both staff and public.

Installation should only be undertaken by contractors observing current OSH requirements for trench and pit installations:

<http://www.osh.govt.nz/order/catalogue/pdf/excavation.pdf>

Site safety guidelines of the installation site and surrounding construction sites must be adhered to. Public access routes (e.g. footpaths) must not be used for the assembly and storage of product during installation.

# Hazards

---

Before commencing the installation of the chamber a full site hazard review must be undertaken.

Working in confined spaces has been identified as a hazard in itself and must be treated accordingly.

Typical hazards associated with working with chambers could be:

- Difficulty of access and egress
- Poor ventilation
- Dangerous gases
- Oxygen deficiency
- Dangers from passing traffic (pedestrian and vehicular)
- Objects falling into the open chamber
- Glass fibres (wear gloves when handling cover sets)

# Staffing requirements

---

It is recommended that a second person is on site at all times during installation.

# Equipment & additional materials

---

In addition to the chamber, base, cover set and reo cages supplied, in order to complete an installation you will need the following:

## Equipment

- The means of digging a hole; mechanical digger or 'jack hammer'
- Shovel or spade
- The means of compacting surrounding material by hand compacting
- Builders trowel
- Straight edge & level
- Tape measure
- Rubber hammer

# Equipment & additional materials (continued)

---

## Equipment (continued)

- Cordless drill c/w hole saws
- Hand saw
- Hacksaw
- Rasp
- Boxing materials for support collar
- Tube silicon sealant

In addition, for installation at a non-level site:

- Levelling Screws (x4)
- Craft knife
- Marker pen

## Materials

- Base material
- Backfill material
- Dricon Easycrete

# Site preparation

Before commencing, lay the chamber base to be installed on the surface of the ground in the location where it is to be installed. Mark around it for the hole to be dug noting the following:

- Allow an additional 150mm excavation around all sides of the chamber, for ease of access during installation and the concrete collar.

## Level Ground Surface:

Dig the hole to the parameters of the marking, and for the depth allow for the following:

1. Depth of frame and cover installed (60mm).
2. Thickness of chamber base (10mm).
3. Depth of chamber sections (multiples of 155mm).
4. Depth of bedding material (25mm – blinding sand).

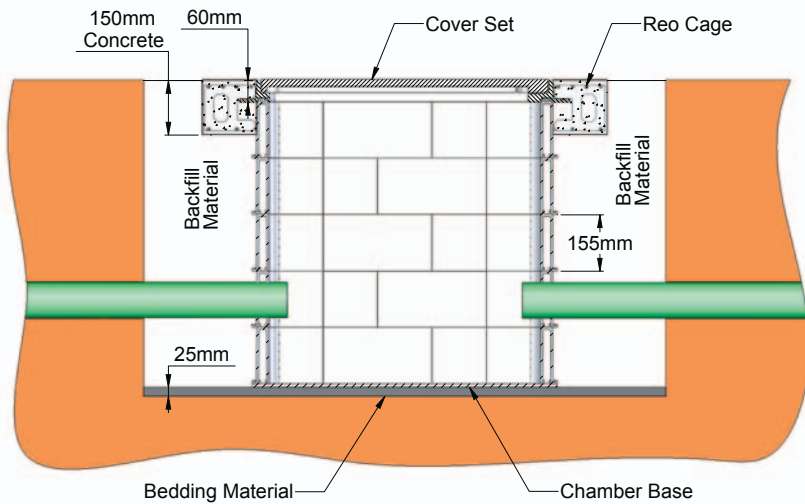

# Site preparation (continued)

## Sloping Ground Surface:

Dig the hole to the parameters of the marking, and for the depth allow for the following at the **lowest point of the slope**:

1. Depth of frame and cover installed (60mm).
2. Thickness of chamber base (10mm).
3. Depth of chamber sections (multiples of 155mm).
4. Depth of bedding material (25mm – blinding sand).

See page 11 for installation guidelines for the leveling system.

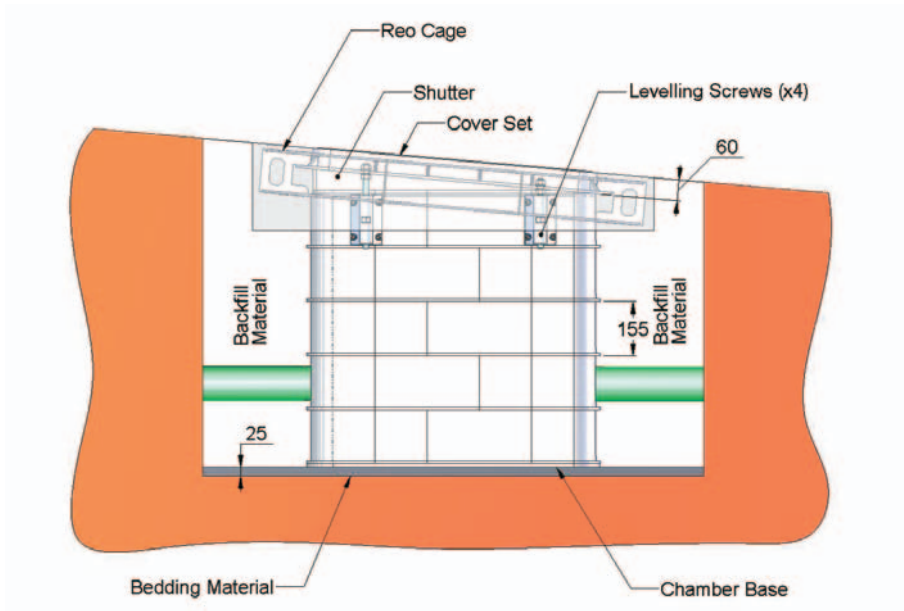

# Chamber assembly

It is recommended that assembly of each layer is completed on site, in advance of actual installation.

Each layer consists of:

Chamber Size	Corner Pieces	150mm Section	300mm Section	375mm Section
600 x 750	4	2	4	
600 x 1200	4	2	2	4
1200 x 1200	4	4		8



600 x 750

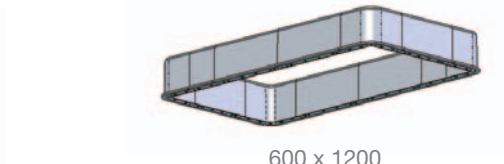

600 x 1200

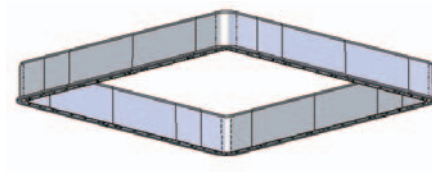

1200 x 1200

Sections are joined together using the joiner pieces supplied:

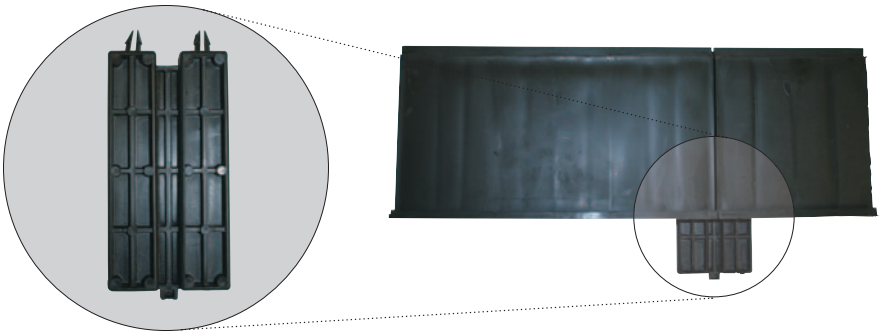

Note: The locking tabs on the joiner pieces should be knocked fully through the holes on the top surface of the wall section.



# Chamber assembly (continued)

---

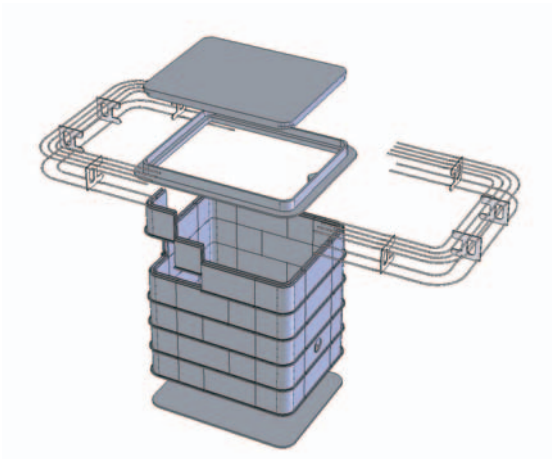

If the chamber layers are left in the sun pre-installation, expansion may occur. In this case, it is necessary to leave one section out of the layer until it is assembled onto the chamber in the ground. This will give more flexibility to ensure layers are locked together. Replace that section as each layer is completed.

## Chamber installation

---

### Installation for new ducting:

1. Place the chamber base onto the prepared bedding and check for a level.
2. Assemble chamber sections on ground surface pre-installation.
3. Place first level onto base and attach with stainless steel screws supplied.
4. Build up additional sections to the required height.
5. Place access cover set frame onto top layer and check for levels to ground surface.
6. Ducting holes can be located as required in the wall structure anywhere above the first layer. Use hole saw to drill holes.
7. Install second layer of chamber around the ducting. Ducts are to be extended through the wall by 50mm and a bead of silicon should be applied on the inside. Ends of the duct must be cut straight and reamed on the inside to remove any sharp edges.

See backfill instructions.

# Chamber installation (continued)

## Installation for jointing chamber over existing ducting:

1. Place the chamber base onto the prepared bedding by sliding under the existing ducts and check for a level.
  2. Allow for one full chamber section under the existing ducting.
  3. Assemble chamber sections on ground surface pre-installation.
  4. Place first level onto base and attach with stainless steel screws supplied.
  5. Mark location of ducting on the second chamber level.
  6. Ducting holes can be located as required in the wall structure anywhere above the first layer. Use hole saw to drill holes.
  7. If ducting is entering the chamber at an angle, then this hole should be drilled at the same angle.
  8. Vertically cut through the wall section at the centre of the hole – this will allow the wall section to be fitted back around the existing ducting (See diagram below).
  9. Install second layer of chamber around the ducting. Ducts are to be extended through the wall by 50mm and a bead of silicon should be applied on the inside. Ends of the duct must be cut straight and reamed on the inside to remove any sharp edges.
  10. Build up additional sections to the required height.
  11. Place access cover set frame onto top layer and check for levels to ground surface.
- See backfill instructions.

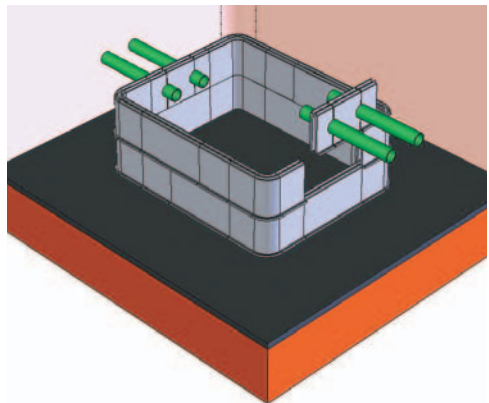
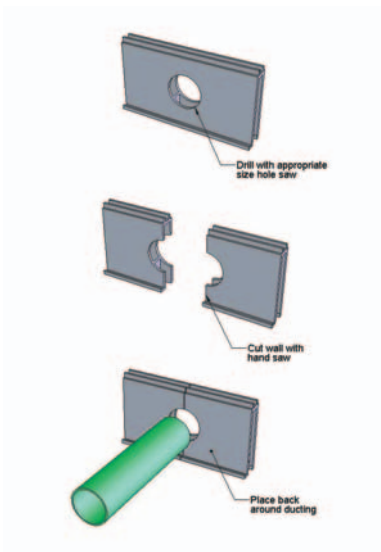

# Chamber bracing

---

1. Bracing must be used prior to backfill for the 600 x 1200 and 1200 x 1200 chambers.
2. Using the wooden pallet supplied for delivery of the chamber system, take 2 pieces of 150 x 25mm timber and cut to length just under the height of the frame.
3. Then, use 2 pieces of 75 x 50mm timber from the pallet feet and cut to form the cross braces.
4. Bracing must be left in place during back fill of the chamber.

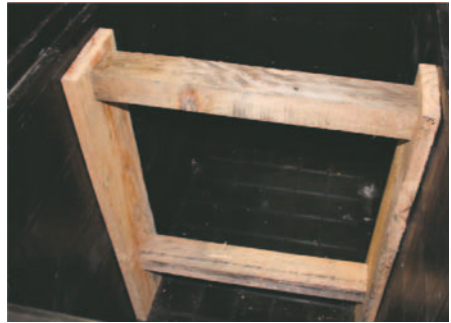

# Chamber backfill

---

1. Place cover in frame to prevent backfill material falling into chamber and replace plugs into bolt hole and key holes.
2. Backfill surround of the chamber can now commence.
3. An initial 100mm layer of backfill material must be placed and then compacted around the entire chamber to ensure the chamber is firmly held in place.
4. Backfill evenly the remaining depth of chamber and compact as necessary.
5. Backfill should be to a level of 150mm below the top of the frame.



# Finishing the installation

---

## Level Ground Surface

1. Place the 2 FRP Reo cages supplied, on either end of the frame.
2. The cages must have 4 reo bars on the top surface as shown below.
3. Where the bars overlap, use the cable ties supplied to attach the bars together as shown, ensuring the cable tie tails are not pointing up.
4. For installation on level ground, box up a 150mm collar area around the reo cages.
6. Pour the concrete to form a support collar.
7. Trowel mortar up to top of frame and finish the concrete to ensure smooth surface.
8. Place locking bolt in cover and secure.
9. Finally reinstate the surrounding surface level as required.



## Sloping Ground Surface

---

1. A set of four (4) levelling screws and mounting blocks is included with the chamber to enable the coverset frame to be height and camber adjusted.
2. Place the cover set frame flat on chamber and locate four slots in the frame. Place the levelling screws into slot with the mounting block flush to the chamber wall.
3. Use screws provided to secure the four mounting blocks to chamber wall.
4. Remove frame and adjust lower nut and washer on the four levelling screws to approx heights required.
5. Place frame back onto levelling screws.
6. Adjust heights required and secure in place with top nut and washer.
7. Replace cover.



# Sloping Ground Surface (continued)

8. Once final levels are set and before setting up reo and boxing, install shuttering (see instructions below).
9. Use a hand saw to cut the excess length from the threaded rod, to below the top surface of the frame.
10. Install reo cages and pour concrete collar as per instructions above. **Ensure a wet mix of concrete is vibrated to ensure it flows and fills all voids under the cover frame.**

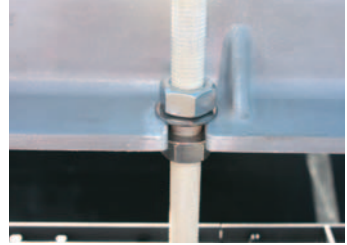

# Shuttering Installation

## Equipment

- Humes shutter pack – purchased separately (shutter pack order codes – 90966 (600 x 750 & 600 x 1200), 90967 (1200x1200))
- Craft knife
- Cloth to wipe surface clean

1. Prepare surface of cover set frame and top of the chamber by wiping clean and dry with a cloth.
2. Apply tape to full internal surface of cover set frame and at the top of the inside surface of the chamber.

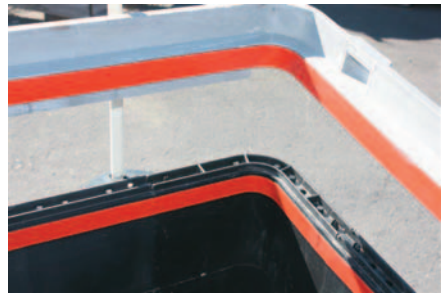

3. Cut four corner pieces from roll of shuttering material approx 30cm long.
4. Remove red backing from the tape.
5. Bend shuttering material and press into the corner so it adheres to the two strips of tape.



# Shuttering Installation (continued)

6. Once all four corner pieces have been applied, cut the remaining shutter material to lengths that will fill in between the corners.
7. Apply force by hand to ensure the shuttering material adheres to the tape along all surfaces.



## Shuttering and Concrete Collar Visual Check



1. Shuttering system correctly installed



2. Correct concrete finish

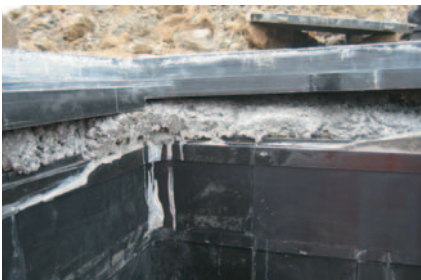

3. Incorrect concrete finish



4. Completed installation

### Notes:

- The shuttering system must be removed after the concrete has set.
- Excessive use of a concrete vibrator may cause the shutter seal to be broken.

# Standards

---

## Cover Sets

1. AS3996:2006 Access Covers & Grates
2. AS3661:1993 Slip resistant Surfaces

# Contacts

---

Humes 0800 502 112

**Humes Pipeline Systems**

A FLETCHER CONCRETE & INFRASTRUCTURE LIMITED BUSINESS

**0800 502 112**