

Titan Concrete Pipe

Ducting

Box Culverts

Manholes

Sumps

Catchpits

Cesspits

Tanks & Traps

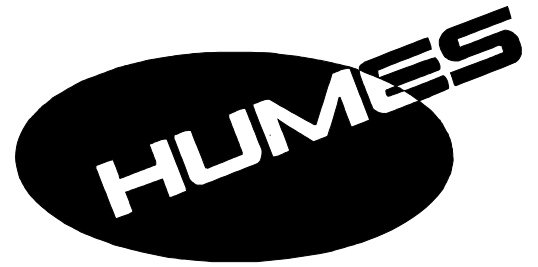

# Concrete Pricelist

Upper North Island

FEB 2005

# Contents

Not all items are available at all stores.



- All prices are accurate at the time of printing and are subject to change.
- All prices are ex yard. Freight to site is extra.
- All sizes are nominal. For a more accurate description, please see a Sales Assistant.
- All prices are exclusive of GST.

Concrete Pipe .....	3
Manhole Risers .....	6
Manhole Risers on Base .....	7
Manhole Lids .....	8
Manhole Accessories .....	9
Cesspits .....	10
Sumps .....	11
Tanks & Traps .....	12
Channel, Wingwalls, & Box Culverts .....	13
API Oil Interceptor Sand Filter .....	14
Ducting .....	15

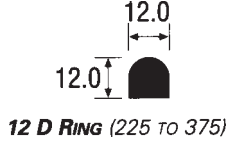
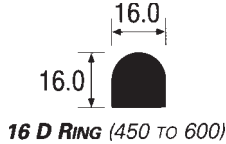

# TITAN Concrete Pipe

N Z S 3 1 0 7

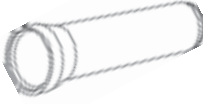
Roller Compacted Pipe Rubber Ring Joint - Class X				Roller Compacted Pipe Rubber Ring Joint - Class Z				Rubber D Ring			
Dia(mm) L(M)	Weight	Item Code	Price \$	Dia(mm) L(M)	Weight	Item Code	Price \$	 12 D RING (225 TO 375)	Size(mm)	Item Code	Price \$
225 x 2000	161kg	31064	109.52	225 x 2000	161kg	31066	117.99		 16 D RING (450 TO 600)	225	81440
300 x 2500	253kg	31074	161.34	300 x 2500	254kg	31076	193.36	300		81441	5.11
375 x 2500	313kg	31114	236.72	375 x 2500	313kg	31116	277.51	375		81442	5.23
450 x 2500	433kg	31124	307.87	450 x 2500	433kg	31126	349.14	450		81443	9.10
525 x 2500	568kg	31375	392.65	525 x 2500	569kg	31376	450.32	525		81444	10.13
600 x 2500	726kg	31404	478.14	600 x 2500	727kg	31406	589.30	600		81445	11.12
											

Spun Pipe Rubber Ring Joint - Class X				Spun Pipe Rubber Ring Joint - Class Y				Spun Pipe Rubber Ring Joint - Class Z				Rubber Ring		
Dia(mm) (LM)	Weight	Item Code	Price \$	Dia(mm) L(M)	Weight	Item Code	Price \$	Dia(mm) L(M)	Weight	Item Code	Price \$	Size(mm)	Item Code	Price \$
675 x 2440	755kg	31431	609.53	675 x 2440	860kg	31432	663.40	675 x 2440	956kg	31433	858.89	675	72828	13.16
750 x 2440	890kg	31461	723.15	750 x 2440	970kg	31462	781.04	750 x 2440	1,140kg	31463	903.92	750	72831	20.80
825 x 2440	1,208kg	31471	794.46	825 x 2440	1,203kg	31472	961.71	825 x 2440	1,390kg	31473	1,040.22	825	72834	21.86
900 x 2440	1,470kg	31491	989.93	900 x 2440	1,510kg	31492	1,078.87	900 x 2440	1,620kg	31493	1,198.86	900	72836	27.33
975 x 2440	1,800kg	31511	1,161.27	975 x 2440	1,680kg	31512	1,187.98	975 x 2440		31513	1,734.33	975	72839	35.16
1050 x 2440	2,016kg	31531	1,434.57	1050 x 2440	2,070kg	31532	1,485.32	1050 x 2440	2,296kg	31533	1,604.29	1050	72841	38.21
1200 x 2440	2,225kg	31581	1,601.42	1200 x 2440	2,350kg	31582	1,737.43	1200 x 2440	2,756kg	31583	2,081.31	1200	72843	39.50
1350 x 2440	2,440kg	31591	1,748.45	1350 x 2440	2,585kg	31592	1,826.60	1350 x 2440	3,120kg	31593	2,182.90	1350	72846	46.92
1600 x 2440	3,060kg	31611	2,319.21	1600 x 2440	3,640kg	31612	2,520.45	1600 x 2440	4,110kg	31613	2,747.83	1600	72849	68.18
1800 x 2440	4,400kg	31641	2,875.48	1800 x 2440	4,600kg	31642	3,277.42	1800 x 2440	5,200kg	31643	3,623.18	1800	72853	76.42

Upper North Island

Not all items are available ex stock at all locations.  
All prices are exclusive of GST.

Concrete Pricelist

FEB 2005

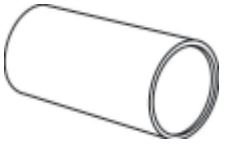
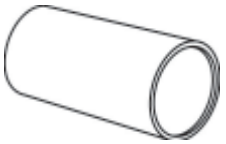
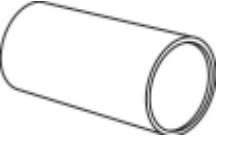

# **TITAN** Concrete Pipe NZS 3107

Flush Joint Pipe External Band Joiner - Class X				Flush Joint Pipe External Band Joiner - Class Y				Flush Joint Pipe External Band Joiner - Class Z				External Band Joiner					
Dia(mm)	L(M)	Weight	Item Code	Price \$	Dia(mm)	L(M)	Weight	Item Code	Price \$	Dia(mm)	L(M)	Weight	Item Code	Price \$	Size(mm)	Item Code	Price \$
600 x 2440		561kg	32241	POA	600 x 2440		561kg	32242	POA	600 x 2440		690kg	32243	POA	600	72870	33.53
675 x 2440			32251	432.43	675 x 2440		771kg	32252	POA	675 x 2440		810kg	32253	POA	675	72871	34.71
750 x 2440		810kg	32261	625.74	750 x 2440		810kg	32262	659.25	750 x 2440			32263	753.72	750	72872	42.93
900 x 2440		1,160kg	32281	833.30	900 x 2440		1,160kg	32282	860.01	900 x 2440		1,400kg	32283	913.21	900	72882	45.93
1050 x 2440		1,460kg	32291	1,055.21	1050 x 2440		1,460kg	32292	1,087.87	1050 x 2440		1,645kg	32293	1,182.61	1050	72874	51.97
1200 x 2440		1,870kg	32301	1,304.84	1200 x 2440		2,010kg	32302	1,489.80	1200 x 2440		2,310kg	32303	1,542.54	1200	72879	93.75
1350 x 2440		2,100kg	32311	3,504.12	1350 x 2440		2,320kg	32312	1,601.71	1350 x 2440		2,900kg	32313	1,784.22	1350	72875	102.11
1500 x 2440		2,550kg	32321	1,883.44	1500 x 2440		2,400kg	32322	2,131.25	1500 x 2440		2,887kg	32323	2,323.94	1500	72878	110.84
1650 x 2440		2,576kg	32331	1,995.67	1650 x 2440		3,200kg	32332	2,289.48	1650 x 2440			32333	3,255.34	1650	72880	120.30
1800 x 2440		3,450kg	32341	2,369.88	1800 x 2440		3,660kg	32342	2,703.86	1800 x 2440		4,500kg	32343	3,278.88	1800	72876	130.00
2050 x 2440		4,260kg	32351	3,026.54	2050 x 2440		4,450kg	32352	3,478.08	2050 x 2440			32353	4,235.84	2050	72881	142.28
2300 x 2440		6,490kg	32361	4,364.82	2300 x 2440		6,620kg	32362	4,870.94	2300 x 2440			32363	5,499.33	2300	72877	162.30
																	

Skid Joint Pipe - Class X				Skid Joint Pipe - Class Y				Skid Joint Pipe - Class Z				Rubber Ring Skid Joint					
Dia(mm)	L(M)	Weight	Item Code	Price \$	Dia(mm)	L(M)	Weight	Item Code	Price \$	Dia(mm)	L(M)	Weight	Item Code	Price \$	Size(mm)	Item Code	Price \$
1950 x 2440		5,920kg	31661	POA	1950 x 2440			31662	POA	1950 x 2400			31663	POA	1950	72856	128.44
2100 x 2440		6,200kg	31671	POA	2100 x 2400		6,700kg	31672	POA	2100 x 2400			31673	POA	2100	72857	141.58
2550 x 2440		9,000kg	32241	POA	2550 x 2440		9,300kg	31692	POA	2550 x 2440		9,300kg	31693	POA	2550	72860	181.81
3000 x 2440		11,000kg	31700	POA											3000	72858	204.59

Upper North Island

Not all items are available ex stock at all locations.  
All prices are exclusive of GST.

Concrete Pricelist

FEB 2005



# TITAN Concrete Pipe

NZS 3107

Jacking Pipe Butt Joint Rubber Ring - Z Class (Steering Band Required)			
Description	Weight	Item Code	Price \$
300 mm x 2.2 Mtr	TBA	31820	POA
375 mm x 2.2 Mtr	TBA	31825	POA
450 mm x 2.1 Mtr	TBA	31830	POA
525 mm x 2.1 Mtr	TBA	31835	POA
600 mm x 2.4 Mtr	TBA	31840	POA
750 mm x 2.4 Mtr	TBA	31845	POA
825 mm x 2.4 Mtr	TBA	31850	POA
900 mm x 2.4 Mtr	TBA	31855	POA
1050 mm x 2.4 Mtr	TBA	31860	POA
1200 mm x 2.4 Mtr	TBA	31865	POA
1350 mm x 2.4 Mtr	TBA	31870	POA
2100 mm x 2.2 Mtr	TBA	31875	POA

Jacking Pipe Butt Joint Rubber Ring - Z Class (Including Galvanized Steering Band)			
Description	Weight	Item Code	Price \$
300 mm x 2.2 Mtr	TBA	31820G	POA
375 mm x 2.2 Mtr	TBA	31825G	POA
450 mm x 2.1 Mtr	TBA	31830G	POA
525 mm x 2.1 Mtr	TBA	31835G	POA
600 mm x 2.4 Mtr	TBA	31840G	POA
750 mm x 2.4 Mtr	TBA	31845G	POA
825 mm x 2.4 Mtr	TBA	31850G	POA
900 mm x 2.4 Mtr	TBA	31855G	POA
1050 mm x 2.4 Mtr	TBA	31860G	POA
1200 mm x 2.4 Mtr	TBA	31865G	POA
1350 mm x 2.4 Mtr	TBA	31870G	POA
2100 mm x 2.2 Mtr	TBA	31875G	POA

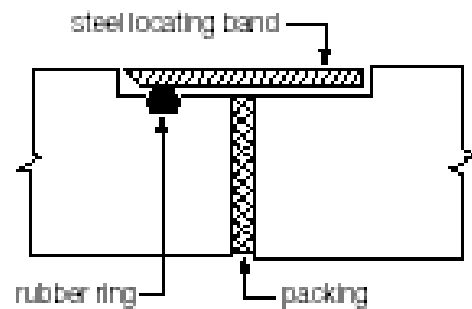

# Manhole Risers

1050 Manhole Riser Standard				
	Dia x L	Weight kg	Item Code	Price \$
	1050 x 300	182kg	02500	135.36
	1050 x 450	261kg	00045	213.00
	1050 x 600	361kg	02501	266.24
	1050 x 900	533kg	02502	397.14
	1050 x 1200	720kg	02503	532.35
	1050 x 1500	888kg	02504	667.56
	1050 x 1800	1,074kg	02505	798.37
	1050 x 2100	1,235kg	02506	929.08
	1050 x 2400	1,383kg	02507	1,064.19

1050 Manhole Riser New Joint				
	Dia x L	Weight kg	Item Code	Price \$
	1050 x 300	182kg	02400	135.36
	1050 x 600	361kg	02401	266.24
	1050 x 900	533kg	02402	397.14
	1050 x 1200	720kg	02403	532.35
	1050 x 1500	888kg	02404	667.56
	1050 x 1800	1,074kg	02405	798.37
	1050 x 2100	1,235kg	02406	929.08
	1050 x 2400	1,383kg	02407	1,064.19

1200 Manhole Riser				
	Dia x L	Weight kg	Item Code	Price \$
	1200 x 300	227kg	02510	174.34
	1200 x 600	442kg	02511	343.17
	1200 x 900	665kg	02512	511.95
	1200 x 1200	865kg	02513	686.28
	1200 x 1500	1,114kg	02514	860.74
	1200 x 1800	1,297kg	02515	1,029.55
	1200 x 2100	1,510kg	02516	1,198.25
	1200 x 2400	1,730kg	02517	1,372.63

1350 Manhole Riser				
	Dia x L	Weight kg	Item Code	Price \$
	1350 x 300	296kg	02520	197.94
	1350 x 600	551kg	02521	389.56
	1350 x 900	899kg	02522	581.19
	1350 x 1200	1,055kg	02523	779.14
	1350 xx1500	1,323kg	02524	977.13
	1350 x 1800	1,583kg	02525	1,168.74
	1350 x 2100	2,684kg	02526	1,360.40
	1350 x 2400	3,165kg	02527	1,558.24

1500 Manhole Riser				
	Dia x L	Weight kg	Item Code	Price \$
	1500 x 300	302kg	02530	204.40
	1500 x 600	583kg	02531	402.23
	1500 x 900	909kg	02532	600.07
	1500 x 1200	1,236kg	02533	891.86
	1500 x 1500	1,515kg	02534	1,008.88
	1500 x 1800	1,748kg	02535	1,206.72
	1500 x 2100	2,204kg	02536	1,404.55
	1500 x 2400	2,536kg	02537	1,608.81

1800 Manhole Riser				
	Dia x L	Weight kg	Item Code	Price \$
	1800 x 300	416kg	02550	308.38
	1800 x 600	819kg	02551	606.91
	1800 x 900	1,272kg	02552	905.40
	1800 x 1200	1,708kg	02553	1,212.40
	1800 x 1500	2,035kg	02554	1,522.20
	1800 x 1800	2,631kg	02555	1,821.05
	1800 x 2100	2,858kg	02556	2,119.26
	1800 x 2400	3,275kg	02557	2,427.50

2050 Manhole Riser				
	Dia x L	Weight kg	Item Code	Price \$
	2050 x 300		02760	382.38
	2050 x 600		02761	764.75
	2050 x 900	1,565kg	02762	1,166.48
	2050 x1200		02763	1,529.49
	2050 x 1500		02764	1,943.50
	2050 x 1800	3,131kg	02765	2,294.23
	2050 x 2100		02766	2,727.63
	2050 x 2400		02767	3,109.99

1050 Manhole Riser - No Holes				
	Dia x L	Weight kg	Item Code	Price \$
	1050 x 100 OJ	58kg	00010	125.14
	1050 x 150 OJ	82kg	00015	131.71
	1050 x 100 NJ	60kg	00016	124.02
	1050 x 150 NJ		00022	131.71

# Manhole Risers on Base

1050 Manhole Riser on Base -Standard				
	Dia x L	Weight	Item Code	Price \$
	1050 x 450	830kg	02738	512.30
	1050 x 600	988kg	02621	595.09
	1050 x 900	1,188kg	02622	729.54
	1050 x 1200	1,350kg	02623	868.33
	1050 x 1500	1,541kg	02624	1,007.17
	1050 x 1800	1,744kg	02625	1,138.65
	1050 x 2100	1,861kg	02626	1,279.00
	1050 x 2400	2,169kg	02627	1,423.73

1050 Manhole Riser on Base -New Joint				
	Dia x L	Weight	Item Code	Price \$
	1050 x 600	988kg	02421	595.09
	1050 x 900	1,188kg	02422	729.54
	1050 x 1200	1,350kg	02423	868.33
	1050 x 1500	1,541kg	02424	1,007.17
	1050 x 1800	1,744kg	02425	1,138.65
	1050 x 2100	1,861kg	02426	1,279.00
	1050 x 2400	2,169kg	02427	1,423.73

1200 Manhole Riser on Base				
	Dia x L	Weight	Item Code	Price \$
	1200 x 600	1,139kg	02631	819.69
	1200 x 900	1,455kg	02632	954.85
	1200 x 1200	1,675kg	02633	1,104.78
	1200 x 1500	2,003kg	02634	1,284.54
	1200 x 1800	2,158kg	02635	1,104.78
	1200 x 2100	2,836kg	02636	1,631.84
	1200 x 2400	2,978kg	02637	1,811.23

1350 Manhole Riser on Base				
	Dia x L	Weight	Item Code	Price \$
	1350 x 600	1,508kg	02641	984.08
	1350 x 900	1,767kg	02642	1,163.62
	1350 x 1200	2,035kg	02643	1,332.15
	1350 x 1500	2,340kg	02644	1,508.85
	1350 x 1800	2,620kg	02645	1,694.89
	1350 x 2100	2,840kg	02646	1,891.96
	1350 x 2400	3,180kg	02647	2,095.39

1500 Manhole Riser on Base				
	Dia x L	Weight	Item Code	Price \$
	1500 x 600	1,733kg	02651	1,293.51
	1500 x 900	2,019kg	02652	1,513.47
	1500 x 1200	2,315kg	02653	1,740.87
	1500 x 1500	2,611kg	02654	1,968.28
	1500 x 1800	2,898kg	02655	2,188.31
	1500 x 2100	3,449kg	02656	2,408.31
	1500 x 2400	3,589kg	02657	2,635.54

1800 Manhole Riser on Base				
	Dia x L	Weight	Item Code	Price \$
	1800 x 600	2,360kg	02671	1,870.73
	1800 x 900	2,700kg	02672	2,189.37
	1800 x 1200	3,180kg	02673	2,517.75
	1800 x1500	3,580kg	02674	2,848.19
	1800 x1800	3,940kg	02675	3,167.57
	1800 x 2100	4,560kg	02676	3,485.67
	1800 x 2400	5,550kg	02677	3,814.78

2050 Manhole Riser on Base				
	Dia x L	Weight	Item Code	Price \$
	2050 x 2400	6,620kg	02678	POA

1050 Manhole Riser on Base - Internal Base				
	Dia x L	Weight	Item Code	Price \$
	1050 x 600	kg	02749	POA
	1050 x 900	kg	02628	POA
	1050 x 1200	kg	02629	POA
	1050 x 1500	kg	02750	POA
	1050 x 1800	kg	02789	POA
	1050 x 2100	kg	02790	POA
	1050 x 2400	kg	02791	POA



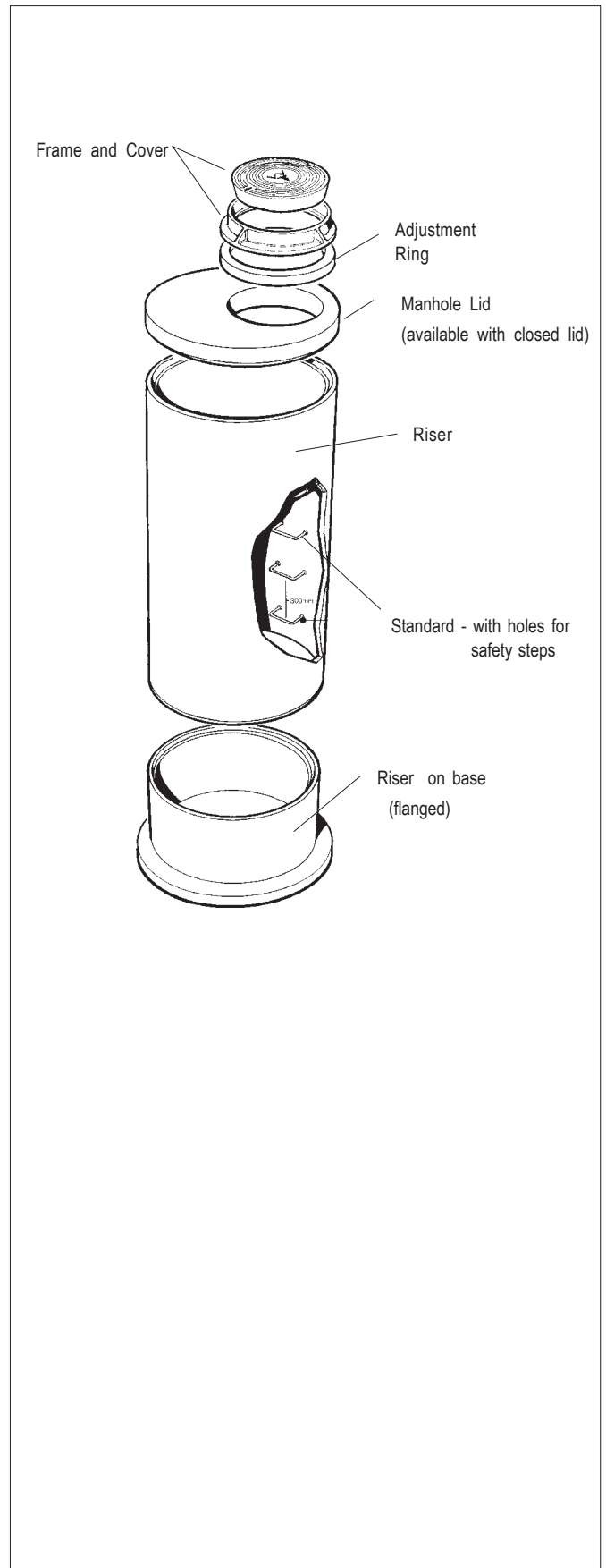

# Manhole Lids

Standard Manhole Lids			
Description	Weight	Item Code	Price \$
1050 x 100	203kg	04085	170.00
1050 x 150	341kg	04086	236.79
1200 x 100	355kg	04089	294.18
1200 x 150	525kg	04090	385.18
1200 x 200	750kg	04091	430.26
1350 x 150	745kg	04093	561.72
1350 x 200	900kg	04094	584.79
1500 x 100	600kg	04151	392.08
1500 x 150	825kg	04096	628.02
1500 x 200	1,105kg	04097	740.11
1800 x 150	1,130kg	04101	833.73
1800 x 200	1,330kg	04102	1111.65
2050 x 150	1,688kg	04105	1306.19
2050 x 200	1,780kg	04106	1436.59
Regional Manhole Lids - New Joint			
1050 x 100 - J2	220kg	04285	170.00
1050 x 150 - J2	342kg	04286	236.79
1050 x 225 - J2	535kg	04288	355.35
Manhole Lids - Special			
1050 x 150 closed	400kg	04126	250.69
Manhole Lids - Hamilton City Council			
1050 x 170	500kg	04193	294.99
1200 x 170	580kg	04176	475.81
1350 x 170		04194	587.41
1500 x 200		04299	651.46
1800 x 200		04298	831.78
Manhole Lids - Taupo			
1050 x 150	341kg	04143	195.04



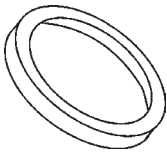

# Manhole Accessories

Adjustment Rings			
	30	78156	31.38
	50	76878	38.75
	75	76879	45.46
	100	76873	50.91
	150	76874	53.31
	200	76875	66.02
	250	76876	75.01
	300	76883	79.25

Manhole Connectors			
	110	73628	159.60
	160	73630	225.15
	225	77610	738.75

Safety Landing			
	1050	75386	854.62
	1200	75380	1015.38
	1350	75394	1438.46
	1500	75381	1895.38
	1800	74724	2589.23

Manhole Grilles			
	1050	77600	1111.85
	1200	77240	1303.08
	1500	77241	2181.38
	1800	77242	2876.92

Safety Steps			
	Galvanised	75353	16.97
	Galv Long Reach	75351	20.82
	Stainless	75349	39.42

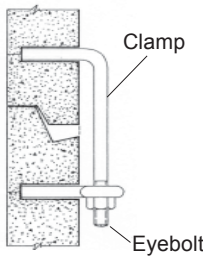
Clamps			
	200	75354	5.68
	250	75355	6.23
	550	75357	10.45

Sealing Strip			
	12mm Titanseal	75416	16.90
	17mm Titanseal	80130	17.94
	16mm sealastrip	80698	17.94

Cement, Mortar & Aggregates			
	Cement - GP 40 Kg	75501	12.13
	Cement - GP 25 Kg	75505	10.68
	Dricon Mortar Plaster 25 Kg	75512	14.18
	Dricon Handicrete 40 Kg	75510	17.10
	Dricon Handicrete 25 Kg	75530	11.37
	Dricon Rapid Set 25 Kg	75231	12.64
	25Kg Bag Builders Mix	75502	5.50
	40Kg Bag Plaster Sand	75503	6.00

HumeBond Epoxy Mortar			
	1 litre	75001	27.00
	2 litre	75002	42.40
	8 litre	75003	123.00
	20 litre	75028	290.40

Swiftlift Lifting Eyes			
	1.3T	73292	126.10
	2.5T	73293	173.95
	5.0T	73294	278.31

# Cesspits

Cesspit Flat Top			
Description	Weight	Item Code	Price \$
300 x 300 x 600	150kg	04200	119.46
450 x 300 x 600	205kg	04252	146.91
450 x 300 x 900	305kg	04234	152.79
450 x 450 x 900	405kg	04204	222.16
450 x 450 x 1220	568kg	04201	275.74
675 x 450 x 1220	629kg	04208	300.29
675 x 530 x 1220	720kg	04268	325.68
675 x 450 x 1650	1,119kg	04262	453.64

Cesspit Riser			
Description	Weight	Item Code	Price \$
450 x 450 x 300	106kg	04203	77.48
675 x 450 x 300	152kg	04210	120.57
675 x 450 x 600	262kg	04209	148.03
675 x 450 x 100		04324	47.43

Back Entry Cesspit			
Description	Weight	Item Code	Price \$
675 x 450 x 1220	638kg	04207	300.29
675 x 450 x 1650	900kg	04206	453.64

Accessories			
Description	Weight	Item Code	Price \$
Kerb Block	75kg	04211	56.91
Cast Iron Kerb Plate		74743	164.37
Ike Type B/Block 160	36kg	04269	43.91
Ike Type B/Block 200	62.5kg	04271	43.91

Tauranga			
Description	Weight	Item Code	Price \$
Kerb Block Back Entry		04260	72.50

Hamilton City Council			
Description	Weight	Item Code	Price \$
HCC Kerb Block		77704	36.19
HCC Grated Sump Top	180kg	04239	524.48

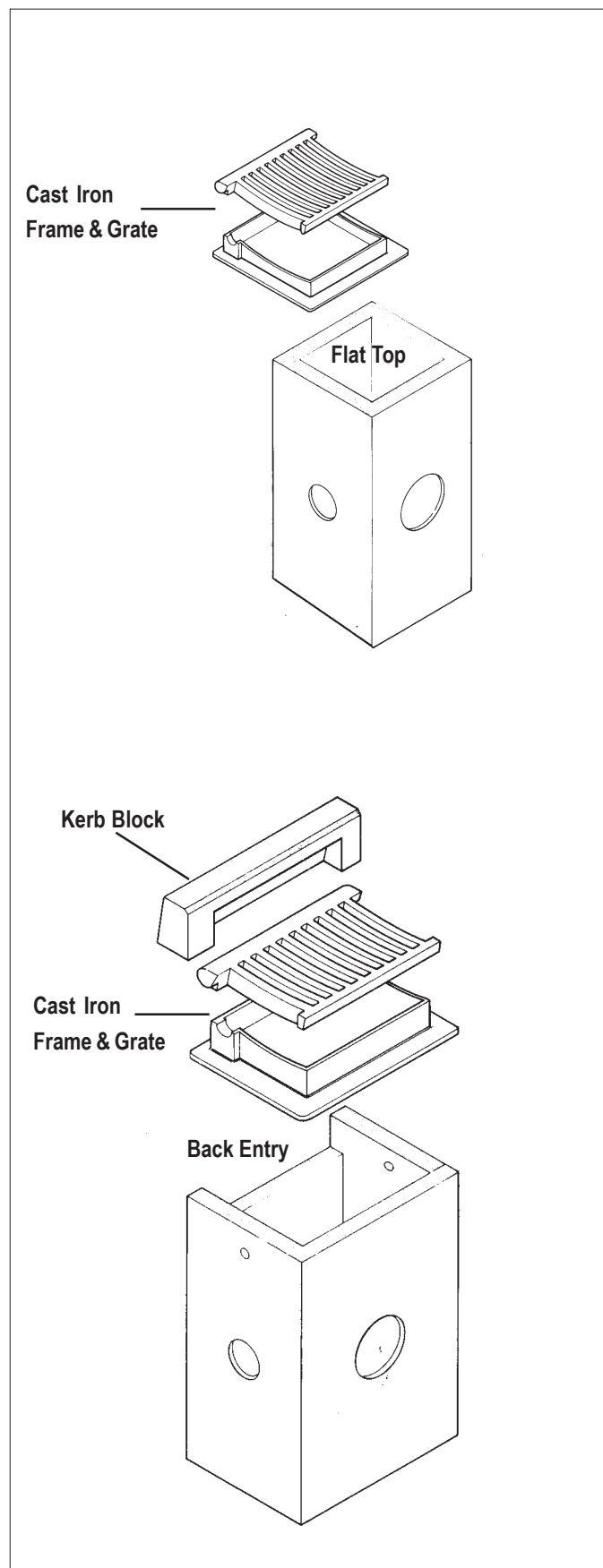

# Sumps

Circular Sumps			
Description	Weight	Item Code	Price \$
300 x 600	54kg	00501	97.65
300 x 900	72kg	00502	135.03
600 x 300	60kg	00520	70.40
600 x 600	140kg	00521	131.49
600 x 900	210kg	00522	184.61
600 x 1200	320kg	00523	229.43
Circular Sumps on Base			
600 x 600	215kg	00561	196.75
600 x 900	285kg	00562	246.86
600 x 1200	320kg	00563	291.17
Sump Lids - closed			
600 x 50	44kg	04131	60.92
600 x 75	62kg	04079	78.11
750 x 100	90kg	04135	87.93
Catchpit - Standard			
750 x 1200 Sump	396kg	00536	331.50
750 x 1500 Sump	732kg	00542	443.88
Catchpit Slab	264kg	04212	181.54
Catchpit Inspection Lid	52.5kg	04259	66.46
Cast Iron Catchpit Lid only	15kg	74865	149.78

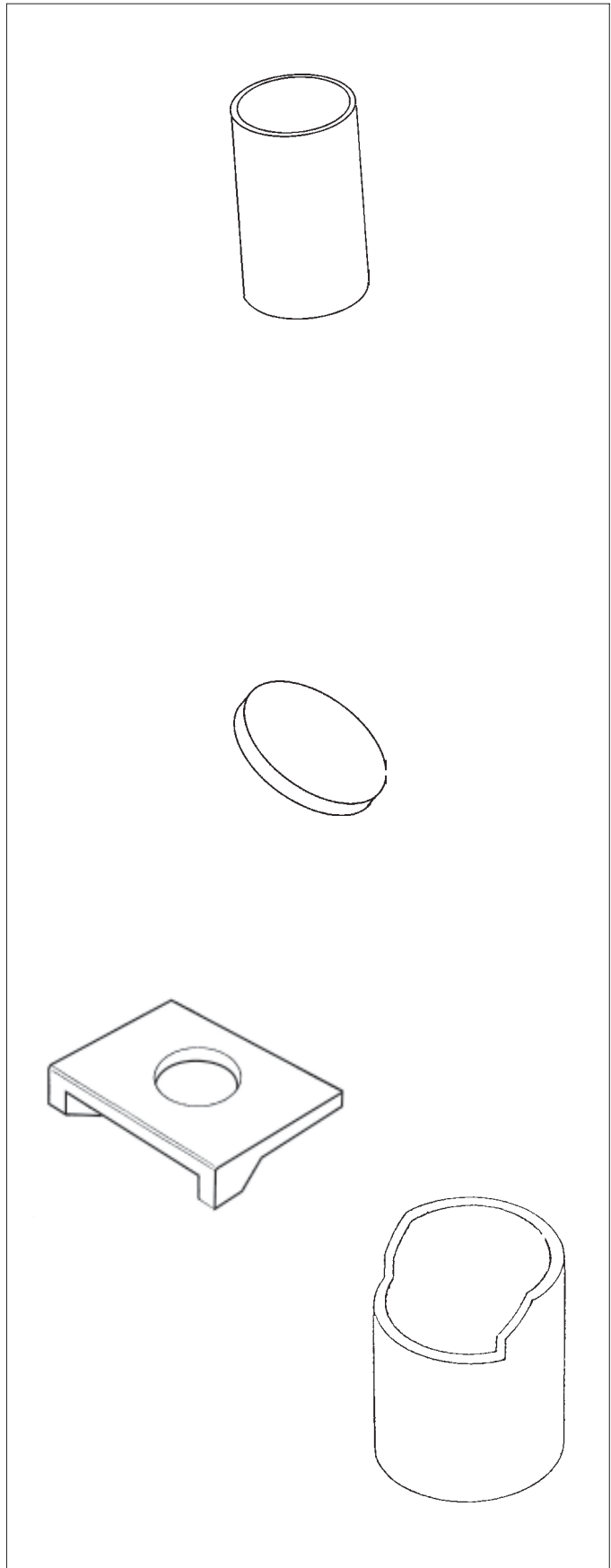



# Tanks & Traps

Septic Tanks			
Description	Weight	Item Code	Price \$
1800 litre	1500kg	05056	1,333.95
2700 litre	2500kg	05008	1,548.23
3300 litre	2700kg	05011	1,821.12
3300 litre with Filter	2,750kg	05014	POA
4100 litre	3500kg	05057	2,004.09
RD5000 litre	4000kg	05780	3,432.13

Oil & Grit Interceptor			
Description	Weight	Item Code	Price \$
2700l interceptor body only	2,160kg	04759	2,438.38
Oil & Grit Lid with 2 or 3 Holes	940kg	04668	532.19
Oil & Grit Lid with two non rock frame & covers and one frame & grate	1,130kg	04710	1,556.47

Grease Traps			
Description	Weight	Item Code	Price \$
100 - 117 Litre concrete	770kg	04600	880.47
Chequer Plate Lid for 100 Litre 2 units required		75338	121.60
425 Litre concrete	1,500kg	04601	1,163.28
Chequer Plate Lid for 425 Litre 3 units required		75339	137.74
222 - 353 Litre concrete trap c/w Lid & Non Rock Cast Iron	1,420kg	04654	1,598.45

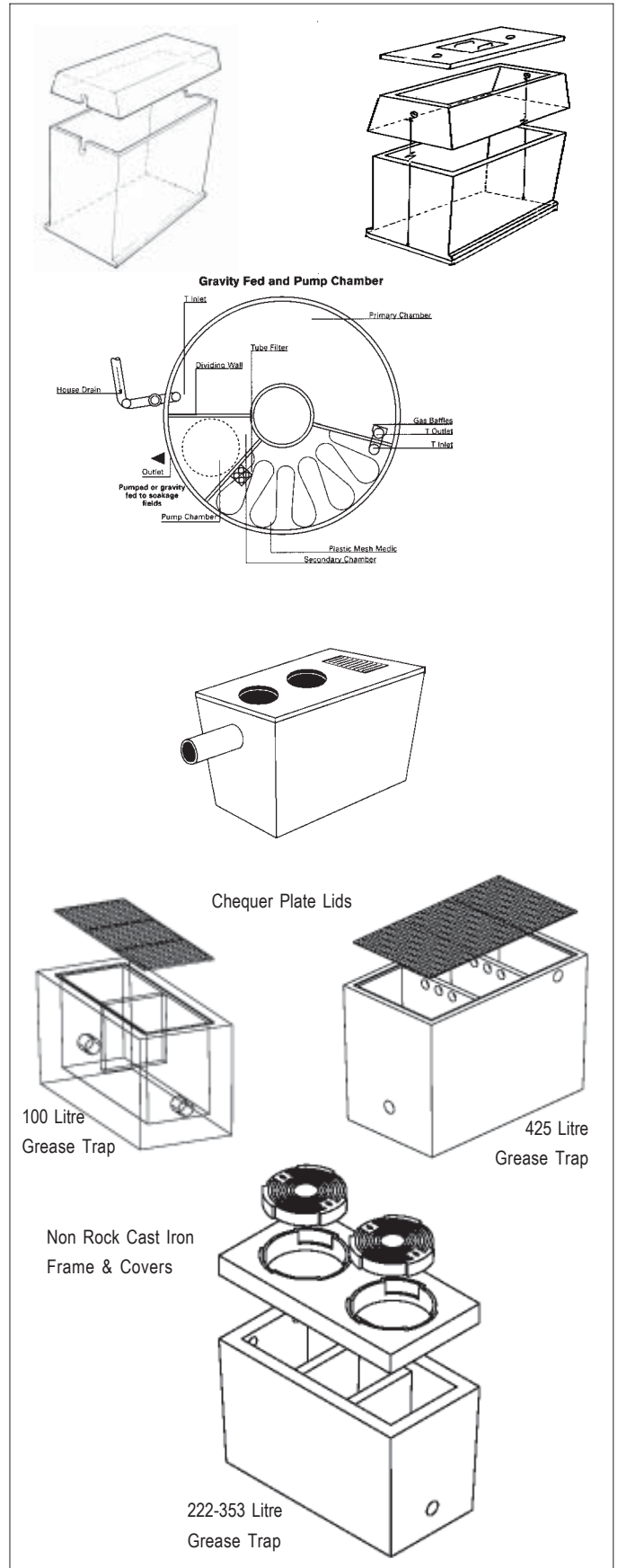

Upper North Island  
Month Year

Not all items are available ex stock at all locations.  
All prices are exclusive of GST.

Concrete Pricelist





# Channel, Wingwalls & Box Culverts

Precast Half Round Channel			
Description	Weight	Item Code	Price \$
225 x 1500	105kg	04407	103.60
300 x 1500	150kg	04410	113.85
375 x 1500	185kg	04412	114.83
450 x 1500	260kg	04413	155.84
Slotblock			
Slot block 1m long	170kg	04636	93.43
Wingwall			
150 - 300	210kg	04640	405.21
300 - 600	670kg	04638	4,67.45
600 - 900	2,210kg	04639	1,113.92
900 - 1050	3,610kg	05536	3,176.08
1200 - 1350	5,270kg	05537	4,665.52
1600 - 1800	7,560kg	05538	6,405.53
Box Culvert			
1500 x 1500 (600)	4,050kg	03825	POA
1500 x 1500 (1500-2000)		03915	POA
2000 x 1500 (500)	4,480kg	03823	POA
2000 x 2000 (500)	5,240kg	03822	POA
2000 x 2000 (2000)	5,200kg	03858	POA
2500 x 2500 (2000)	8,575kg	03857	POA
2500 x 3000 (500)		03817	POA
3000 x 1000 (600)		03927	POA
3000 x 1500 (500)		03816	POA
3000 x 2000 (600)	8,510kg	03815	POA
3000 x 2000 (0-2000)	8,765kg	03859	POA
3000 x 3000 (600)	10,100kg	03813	POA
4000 x 1500 (600)	10,200kg	03805	POA
4000 x 1500 (500-1000)		03835	POA
4000 x 2000 (600)	11,000kg	03804	POA

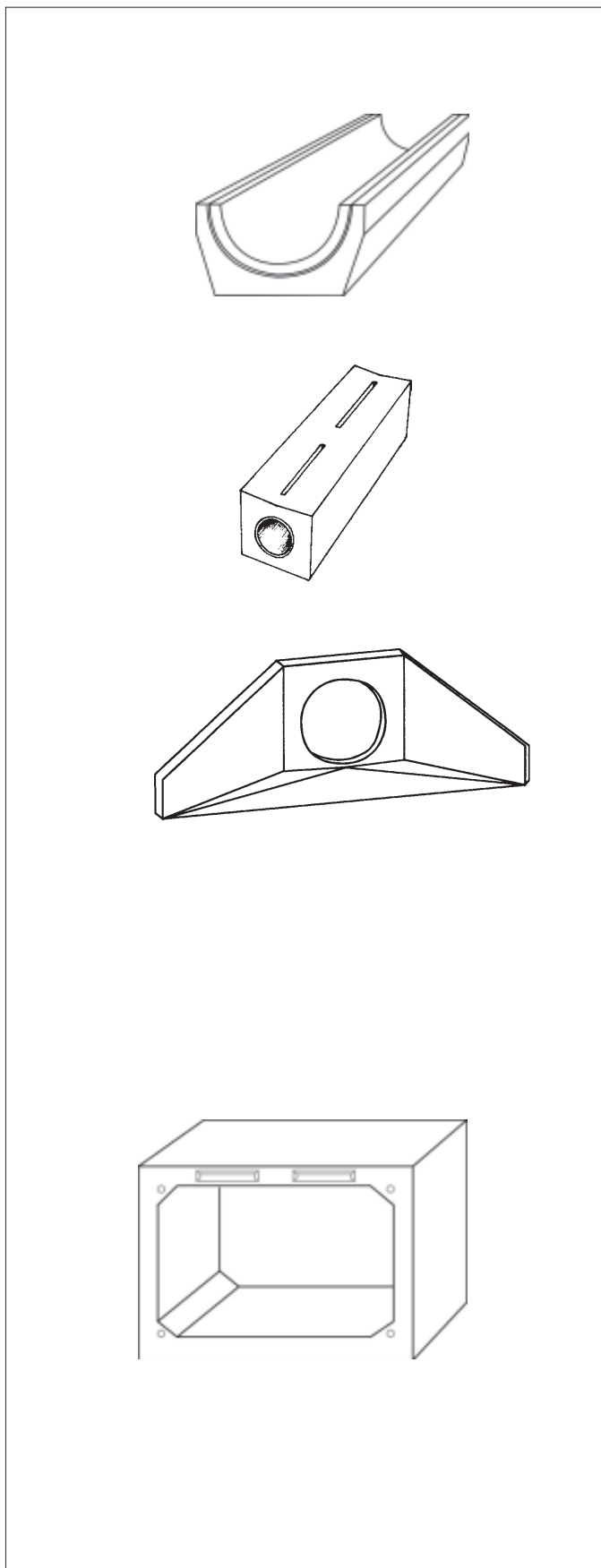

# API Oil Interceptor & Sand Filter

API Oil Interceptor			
Description	Weight	Item Code	Price
3.0 Mtr Unit	9750kg	04070	POA
Lid to suit 3.0 Mtr Unit		04099	POA
3.5 Mtr	10,680kg	04073	POA
Lid to suit 3.5 Mtr Unit	2,860kg	04074	POA

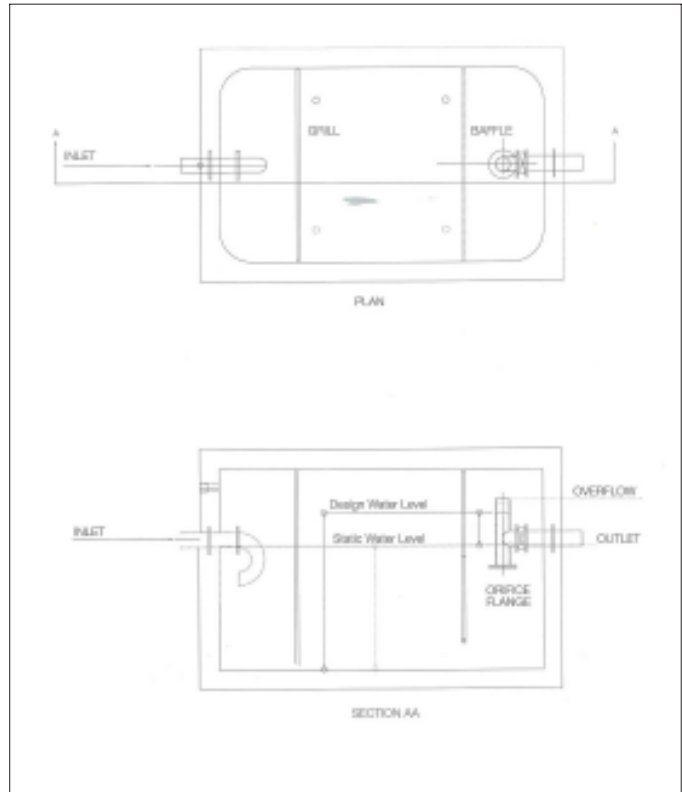

Sand Filter				
Catch. m2	Description	Internal H m m	Total Mass tonnes	Price
500	HSF 500-B1500	1500	13.91	POA
	HSF 500-B2950	2950	11.99	POA
750	HSF 750-B1500	1500	17.86	POA
	HSF 750-B2400	2400	13.99	POA
1000	HSF 1000-B1500	1500	22.15	POA
	HSF 1000-B2950	2950	16.14	POA
1250	HSF 1250-B2000	2000	20.65	POA
	HSF 1250-B2950	2950	18.56	POA
1500	HSF 1500-B2050	2050	23.16	POA
	HSF 1500-B2950	2950	20.98	POA
1750	HSF 1750-B2000	2000	25.45	POA
	HSF 1750-B2500	2500	23.47	POA
2000	HSF 2000-B2200	2200	26.76	POA
	HSF 2000-B3050	3050	23.99	POA

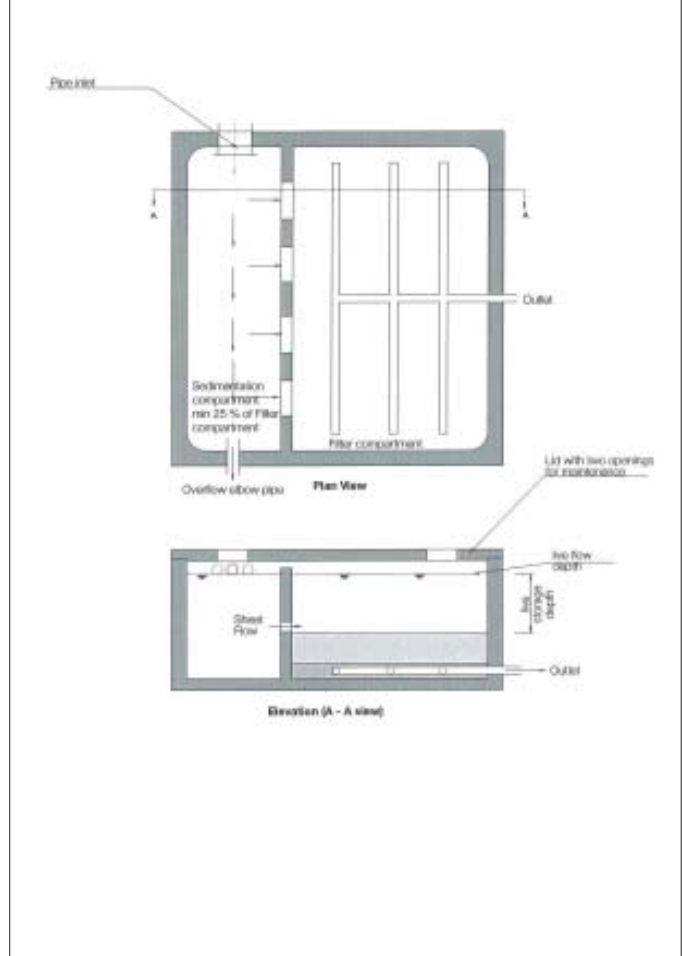

# Ducting

300 Series Ducting			
Description	Weight	Item Code	Price \$
<b>Light Duty</b>			
300 x 150 x 1500 Channel	165kg	04503	114.99
300 x 225 x 1500 Channel	200kg	04504	137.72
300 x 300 x 1500 Channel	220kg	04505	175.72
300 x 75 x 750 Lid (2 per unit)	90kg	04506	83.98
<b>Heavy Duty</b>			
300 x 150 x 2400 Channel	505kg	04507	342.80
300 x 225 x 2400 Channel	605kg	04508	401.95
300 x 300 x 2400 Channel	705kg	04509	503.95
300 x 125 x 1.2 Lid (2 per unit)	190kg	04510	159.36
600 Series Ducting			
<b>Light Duty</b>			
600 x 400 x 2500 Channel	820kg	04514	528.40
600 x 650 x 2500 Channel	920kg	04515	540.25
600 x 75 x 625 Lid (4 per unit)	50kg	04518	70.48
<b>Heavy Duty</b>			
600 x 400 x 2500 Channel	970kg	04516	496.74
600 x 650 x 2500 Channel		04557	639.56
600 x 150 x 1.245 Lid (2 per unit)	400kg	04559	262.90
600 x 685 x 2400 Channel	1070kg	04517	887.97
600 x 150 x 400 Lid (6 per unit)	220kg	04519	203.83
700 Series Ducting			
<b>Light Duty</b>			
700 x 300 x 2400 Channel	890kg	04520	484.22
700 x 450 x 2400 Channel	1060kg	04521	612.82
700 x 600 x 2400 Channel	1235kg	04522	714.92
700 x 900 x 2400 Channel	1570kg	04524	929.92
700 x 100 x 810 Lid (3 per unit)	180kg	04526	127.56
<b>Heavy Duty</b>			
700 x 300 x 2400 Channel	1,128kg	04527	629.96
700 x 600 x 2400 Channel	1,380kg	04529	759.71
700 x 750 x 2400 Channel	1,820kg	04530	849.75
700 x 1070 x 2400 Channel	2,729kg	04532	1,126.25
700 x 160 x 810 Lid (3 per unit)	280kg	04533	174.11
1250 Series Ducting			
<b>Heavy Duty</b>			
1250 x 1060 x 1450 Channel	2,200kg	04534	1,107.58
1250 x 150 x 1450 Lid (1 per unit)	850kg	04536	555.48

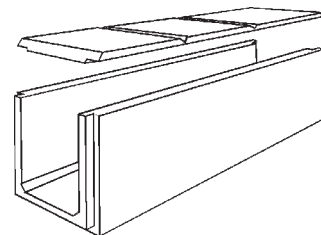
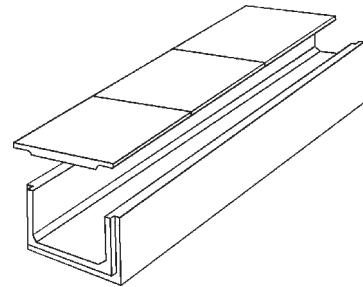
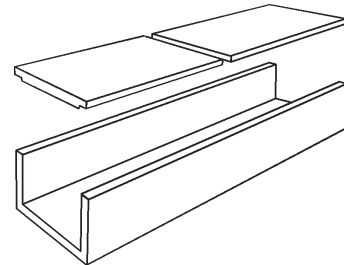
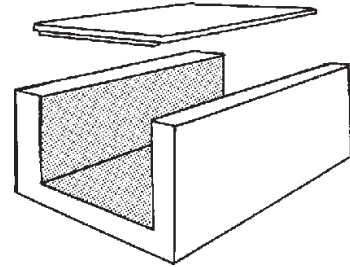

Upper North Island  
Month Year

Not all items are available ex stock at all locations.  
All prices are exclusive of GST.

Concrete Pricelist

